

# GLOBO

LIGHTING

[www.globo-lighting.com](http://www.globo-lighting.com)

41509-6

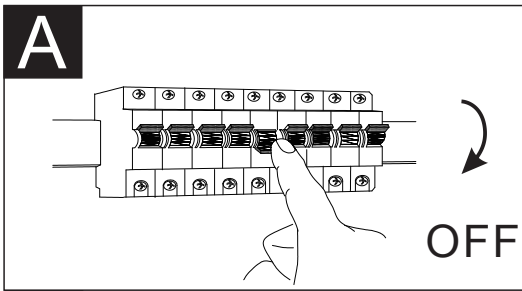

**B**

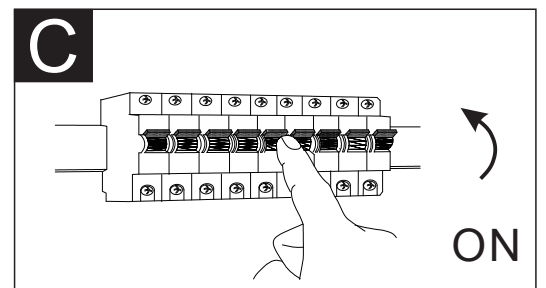
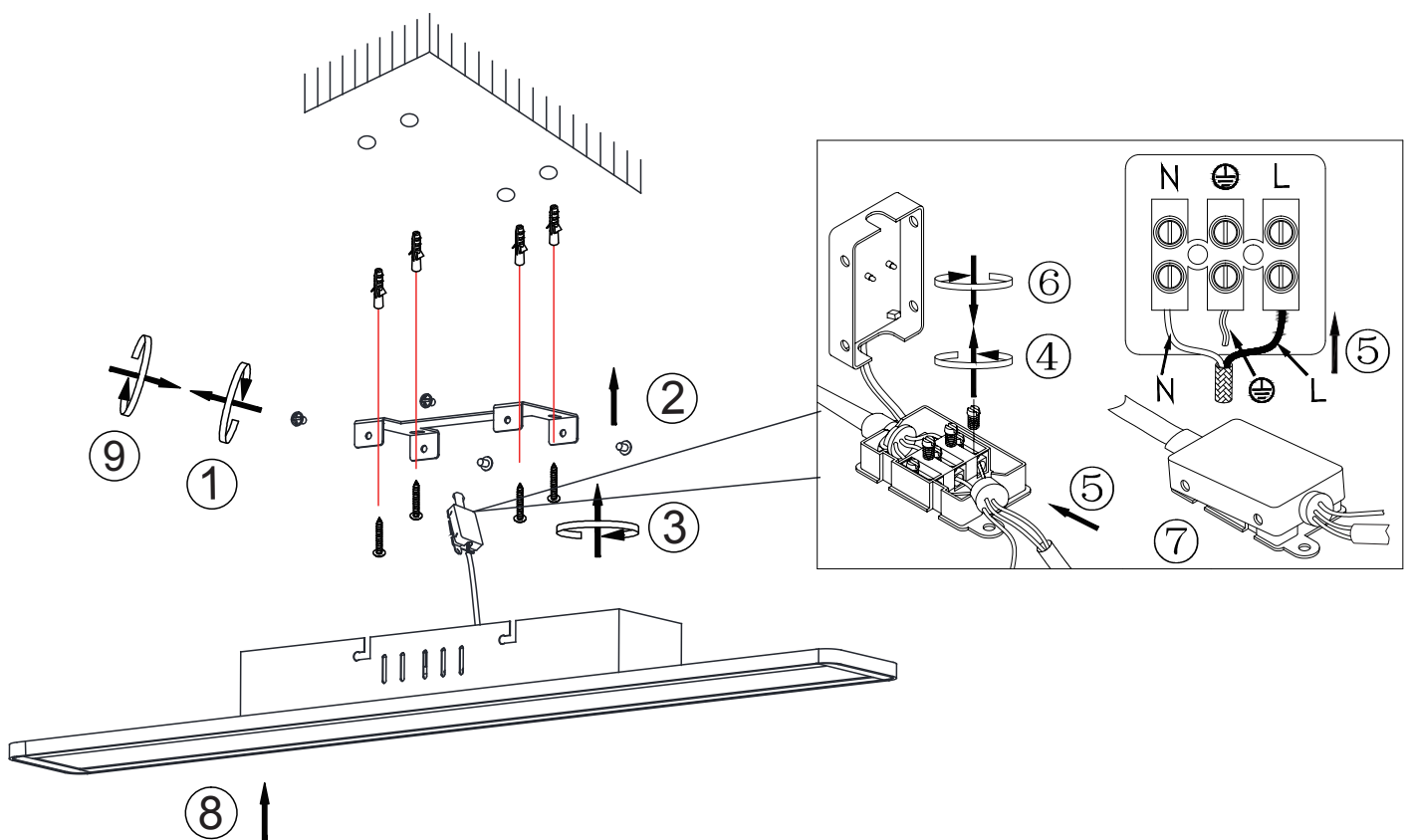

GLOBO Handels GmbH  
Gewerbestr. 3  
A-9184 Sankt Peter